

User/ Product Manual

PRODUCT USE AND CARE INSTRUCTIONS



ELECTRIC BALANCE BIKE

Thank you for choosing X-PRO BALANCE electric balance bike

- X-PRO BALANCE is an electric balance bike for children using
- Before riding, please read this Product Manual carefully, learn Security Warnings and Precautions.
- This manual can help you understand, use and maintain X-PRO BALANCE.



- In order to avoid dangers that are caused by collisions, falls and loss of control, please learn how to ride electric balance bike safely.
- You can learn riding skills by reading this product manual.
- This manual includes all operating instructions and precautions, users must read carefully and follow the instructions. All users are responsible for any consequences that are caused by violating warning contents or prompt operations. We shall not be liable for incidental and consequential damages.

Content

1. BEFORE USING 2

 1.1 Riding Risk..... 2

 1.2 Preparation Before Riding..... 2

 1.2.1 Prepare install the electric balance bike..... 3

 1.2.2 Product specification 4

 1.2.3 Description of parts 5

 1.2.4 How to assemble the X-PRO BALANCE 6

2. Safe-using of electric balance bike 9

 2.1 Weight Limit..... 10

 2.2 Maximum Riding Range..... 10

 2.3 Speed Limited 11

3. Usage of Battery 11

 3.1 Battery power 11

 3.2 Charging process..... 12

 3.3 Temperature 13

 3.4 Description of battery..... 13

3.5 Shipping Notes.....	13
4. Maintenance.....	13
4.1 Cleaning Electric balance bike	14
4.2 Storing Electric balance bike.....	14
5. Service	14

1. BEFORE USING

1.1 Riding Risk

Electric balance bike is a personal electric vehicle toy, our technology and production processes have strict testing for every pair of electric balance bike. Riding without attention to contents of this manual may cause injury.







Falling, losing control, collision, or failure to follow e-balance bike manual, may cause injury even death. In order to minimize the risk of riding, ensure that you read manual.

1.2 Preparation Before Riding

When first open the carton box, the following items can be founded in carton box.

1.2.1 Prepare install the electric balance bike

Main product	
Charger with tool	
Battery	
Manuel	

1.2.2 Product specification

E-balance bike	Net weight	10kgs
	Size	980*510*568mm
	Running time	60-80min (4.0Ah battery)
	Operating temperature range	0°C-40°C
	Max climbing angle	6~9°
	Max weight capacity	50KG
Battery	Capacity	4.0Ah
	Types	18650 high rate discharge battery
	Charging duration	3~6 hours
	Charging times	300 times
Motor	Type	Brush motor
	Highest speed	15KM/H
	Size	104*98*100mm
	Power	100W
Charger	Input	AC 100V-240V
	Charging temperature range	0°C-40°C
	DC dual output	L/R simultaneous output 29.4V/0.6A

1.2.3 Description of parts

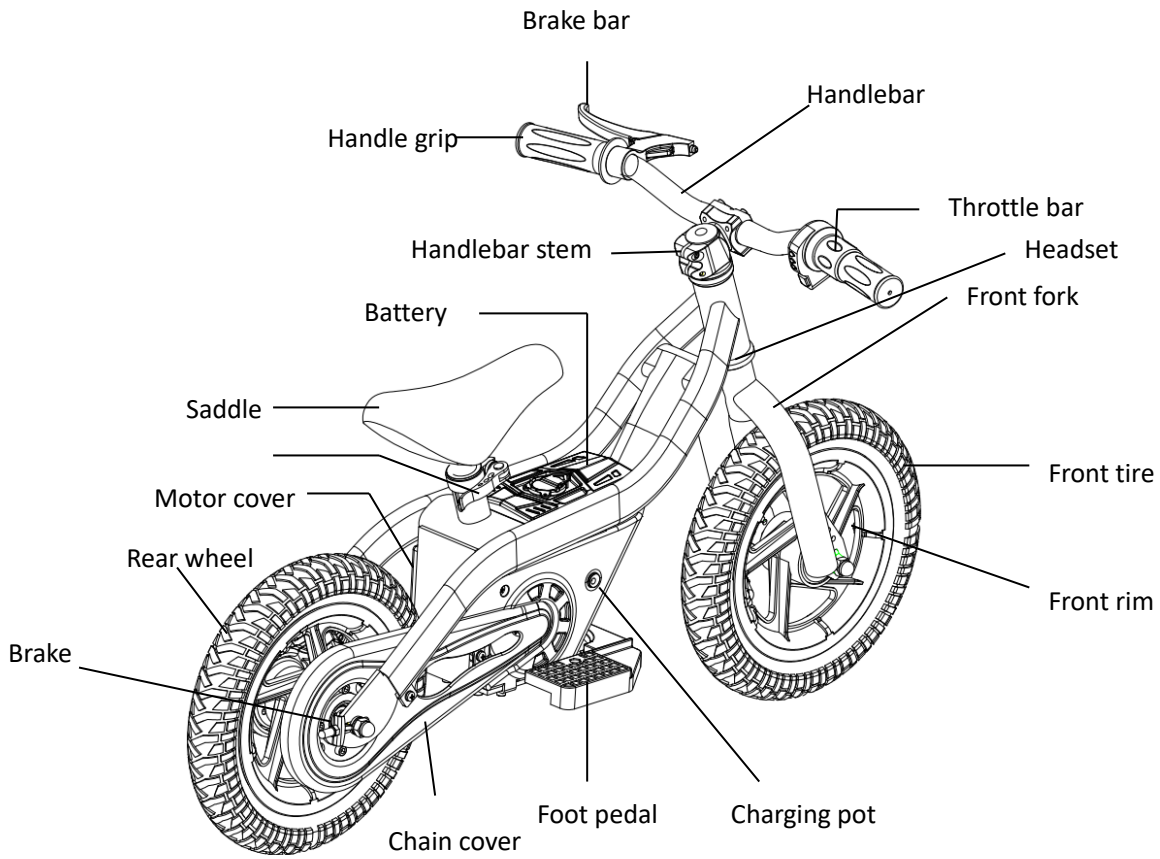

1.2.4 How to assemble the X-PRO BALANCE

STEP 1: Assemble the handlebar

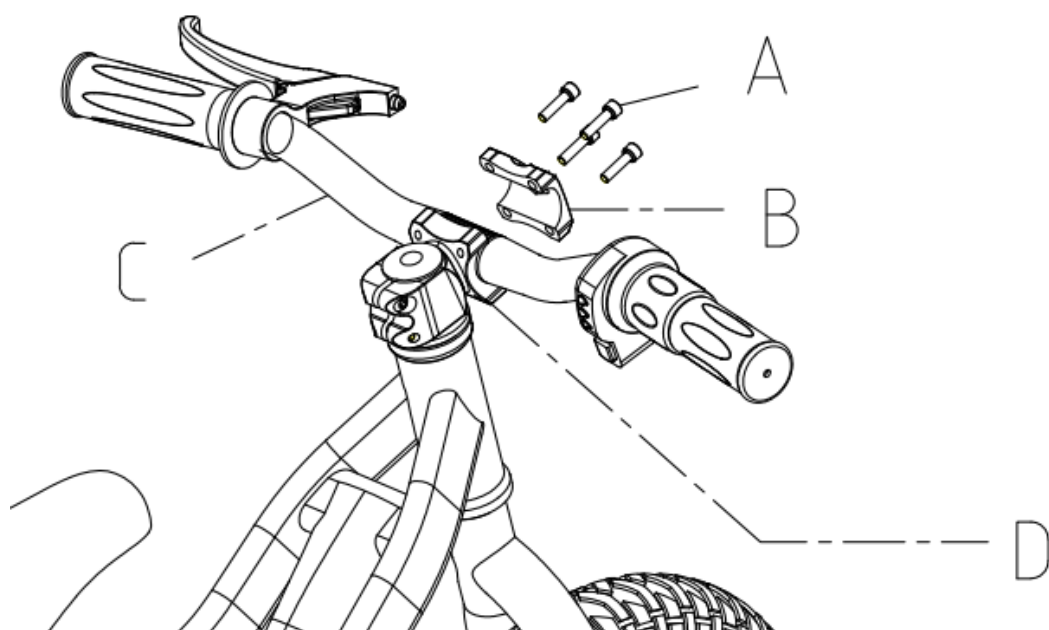

A: Size: M5X20 Socket head bolt

B: Upper block

C: Handlebar

D: Down block

1. Put (C) into location (D) , then cover (B)
2. Put (A) into (B) , then use the tools screw to (D)

NOTE:

When assemble the handlebar, the brake wire should go to the Left side (from front side see) :

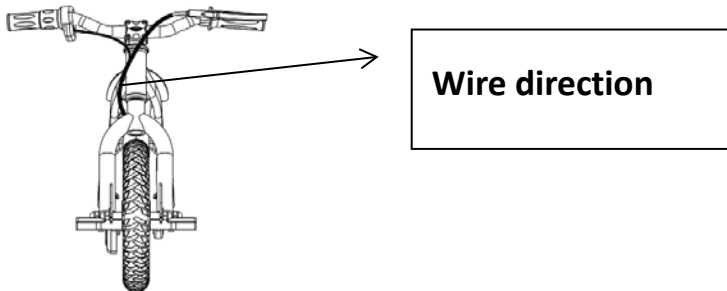

STEP 2 Install the battery

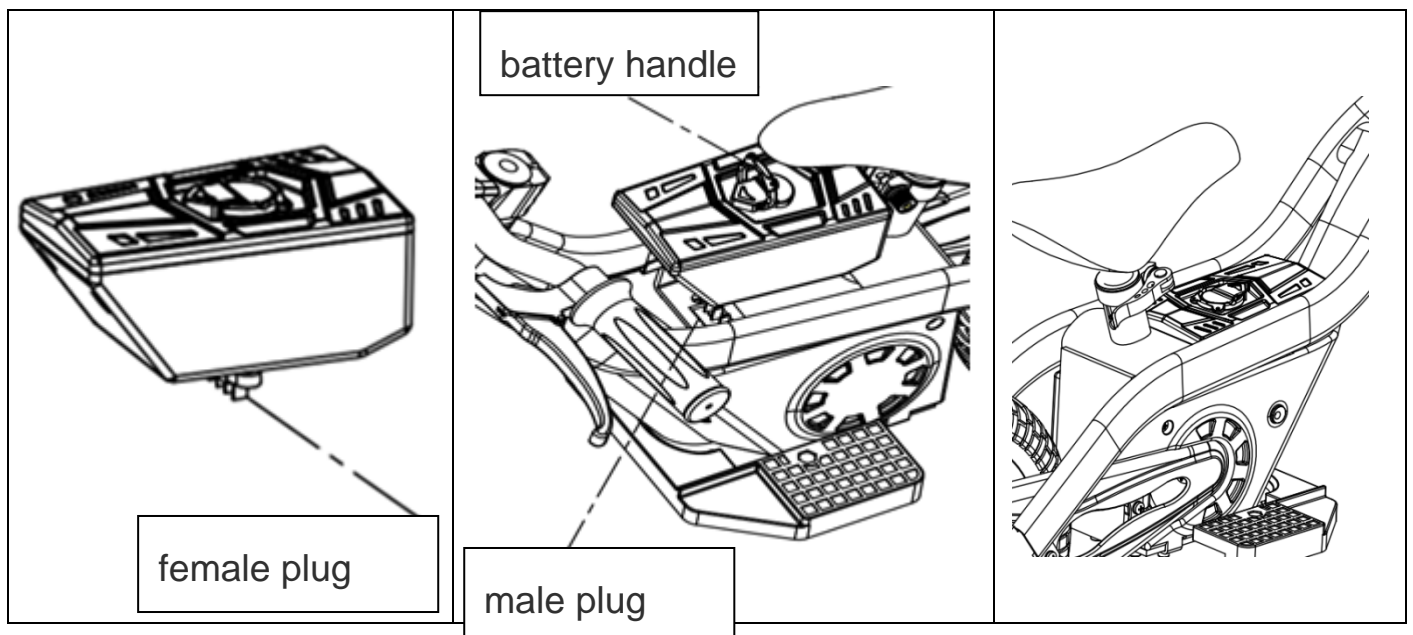

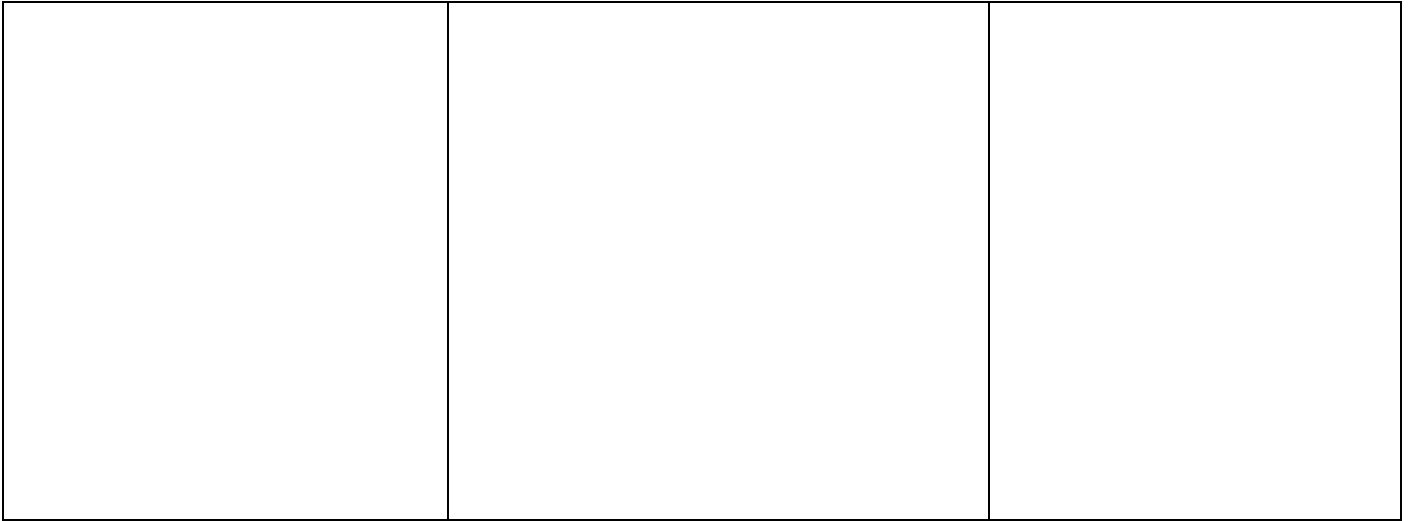

a. Install the battery: Take the battery out, find the female plug in the battery and the male plug in the bike. Match the female plug to the male plug, then press the battery case until the two plugs are completely locked. (Move the battery slowly, if it is a movable battery, it means the plugs are not locked completely. Should press the front part of battery case heavily to make sure the battery is installed.)

b. remove the battery out: Left hand hold the bike, put the index finger of right hand into the battery handle, thumb and middle finger hold the battery case, then pull the whole battery case out.

Step 3 Adjust the saddle

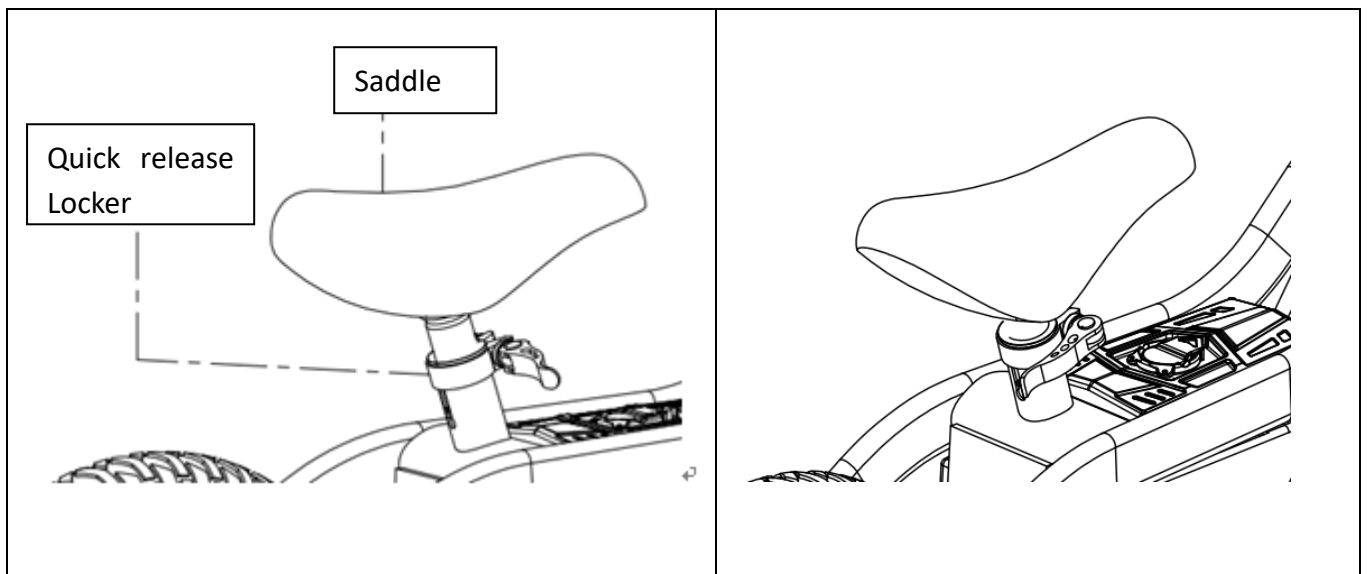

Release the lock, adjust the saddle into the right position, then lock it.

Step 4 Check the battery capacity



Battery capacity display

After install all the above steps, check press the red bottom check the battery capacity.

Full battery capacity: Green, Yellow, Red light on

Half battery capacity: Yellow, Red light on; Green light off

Low battery capacity: Red light on, green and yellow light off

2. Safe using of electric balance bike

We hope every user can ride electric balance bike safely and enjoy the fun. You can recall the memories of learning how to ride a balance bike, electric toy car, bicycle; all these experiences can be applied.

1. Please follow the related content in "product Manual" before riding electric balance bike at the first time. Check whether

battery power is enough, tires are damaged or parts are loose before driving. If there is any abnormal situation, please contact local dealer for repair.

2. Please carefully read the "Product Manual", this will help you to get a lot of important safety information such as speed limited, vibration alert and safety shutdown, etc.

3. Do not use the balance bike incorrectly to endanger the safety of persons or property.

4. Do not modify the parts of electric balance bike, it will affect the performance, and can cause serious injury.

5. The children is not allowed to ride the electric balance bike on his/her own. Children can only ride it when they have been given supervision or instruction concerning use of the appliance by a person responsible for their safety

6. When the user is riding, make sure to wear protectors, such as: helmet, knee pads, elbow pads and other protective gear.

7. It is prohibited to use on road.

8. Please be alert to things in front or far away from children, keeping good vision will keep children safe.

9. Do not ride on slippery and wet surfaces or on rainy days. Do not ride in dark place.

10. Do not ride on obstacles, such as twigs, litter or small stones, etc. Avoid riding in narrow spaces. Avoid riding on a steep slope.

11. To avoid degradation of battery performance by heat, electric balance bike should store in cool dry place out of sunlight.

2.1 Weight Limit

To ensure safety and reduce damage, user must follow minimum and maximum load:

Maximum Load: 50 kgs

Overweight may increase possibility of injury

2.2 Maximum Riding Range

There are a lot of factors that will affect riding range& performance, such as:

Grade: A smooth, flat surface will increase the riding speed, while an incline or hilly terrain will reduce the speed.

Weight: The weight of the user can affect riding speed and riding range.

Ambient temperature: Please ride and store balance bike under recommended temperature, which will increase product lifetime.

Maintenance: Reasonable battery charging and maintenance will increase the product lifetime.

Speed and riding style: Maintaining a moderate speed will increase distance, on the contrary, frequent starting, stopping, acceleration will reduce the product lifetime

2.3 Speed Limited

Electric balance bike top speed is about 10 KM/H

When it is close to the max speed, the electric balance bike will ensure that the speed does not continue to increase. When the user feels discomfort or loss control with the speed, they must hit the brake bar to slow the speed.

3. Usage of Battery

This section mainly describes the charging method of electric balance bike, how to maintain the battery, some security issues, and battery specifications. For users' safety, maximum extent of prolonging the battery life, and improve battery performance, please follow the instructions.

3.1 Battery power

You must stop riding if electric balance bike displays low power, or it may affect battery lifetime.

- Don't use the battery if it emits odor or overheats.
- If the electric balance bike is not used for long time, the battery must be charged every 2-3 months.
- Don't touch any leaking material if any.
- keep battery away from children when not riding.
- The charger must be unplugged from the charging port before riding.
- Battery contains dangerous substances, do not open the battery, do not inset anything into battery.
- The battery must be removed from the appliance before it is scrapped.
- The appliance must be disconnected from the supply mains when removing the battery.
- Please use the charger provided with electric balance bike original.
- Don't over charge the battery
- The battery is to be disposed of safety



For the purposes of recharging the battery, only use the detachable supply unit **FY0632941500** provided with this appliance

3.2 Charging process

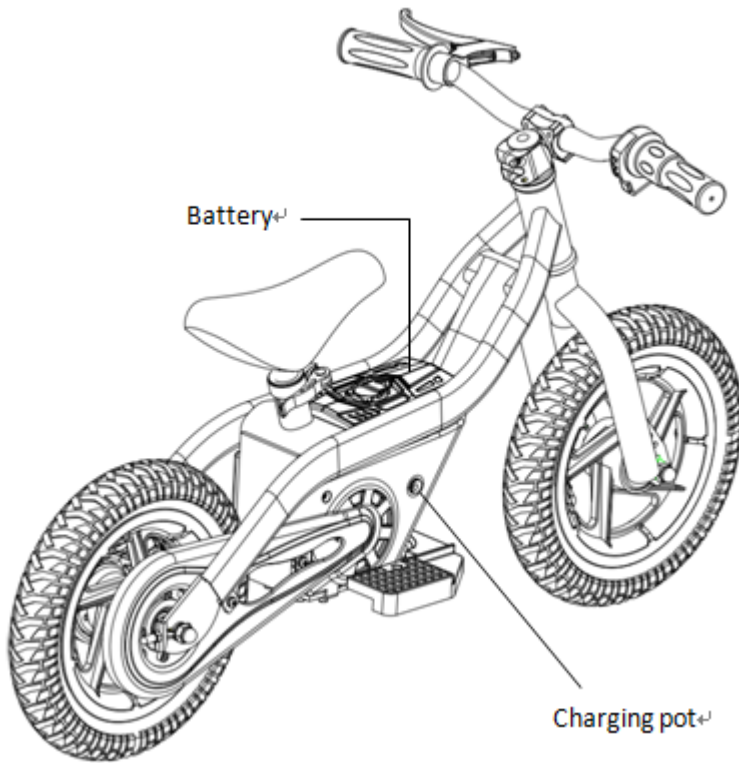

Ensure the charging port is dry

When the Led light turn red, it means low power, then the battery needs to be charged

Switch off the electric balance bike in "off " position

Plug the charger cable into the electric balance bike, connect the cable with power supply. Please refer to power supply for charging state.

The Red light of charger indicates that it has begun to charge, otherwise check whether the cable is connected. When the charger indicates light goes from red to green, it indicates the battery is fully charged.

The charging time is about 3 hours.

Keep the charging environment clean and dry.

3.3 Temperature

The best charging temperature is 10 degree to -40 degree. Over cold and over hot will not completely charge the battery

3.4 Description of battery

Contents	Parameters
Battery	Lithium battery
Charging time	2~3h
Voltage	24V
Initial Capacity	2Ah or 4Ah
Working Temperature	-15°C~50°C
Charging Temperature	10°C~40°C
Storage Time (-20°C~ 35°C)	12 months (Charge every 2~3 months)
Storage Humidity	~65%

3.5 Shipping Notes

Lithium battery contains dangerous articles. Ship lithium only according to local law.

4. Maintenance

Electric balance bike requires the user to do routine maintenance.

This chapter describes maintenance steps and important operating tips.

Before you perform the following operations, ensure the power and charging cable are disconnected. If the battery is charging, the operation is not allowed.

4.1 Cleaning Electric balance bike

Disconnect the charger and turn off Electric balance bike

Wipe the cover



Avoid using water or other liquids on the Electric balance bike for cleaning. If water or other liquids seep into Electric balance bike, it will cause permanent damage to the internal electronics.

4.2 Storing Electric balance bike

- fully charge your battery before storing
- Charge products at least every two to three months.
- If the storage ambient temperature is below 0 degree, please do not charge. You can bring the Electric balance bike into a warm environment (about 10 degree) for charging.
- To prevent dust from entering, you should cover Electric balance bike. Do not connect the power.
- Store Electric balance bike indoors in a dry and suitable temperature. If you do not use it for a long time, please do not connect the power.



Do not disassemble Electric balance bike. Users who try to disassemble Electric balance bike lose their right for guaranty.

5. Service

Thank you again for your purchasing Electric balance bike, we would like to provide you good after-sale services since your purchasing date.

The warranty period is consistent with the national and local warranty policy.

The warranty period is calculated from original date of purchase by the user.

A proof of purchase must be given when claiming this warranty; the original sales receipt is considered such proof.

EXCLUSIONS:

This warranty does not apply to:

Damage caused by misuse, accident or abuse.

Damage caused by service performed by any third part.

A product or part that has been modified without the written permission.

WARRANTY DOES NOT COVER:

Product repair and/or part replacement because of improper installation, connections to improper voltage supply abuse, neglect, accident, unauthorized repair or other cause not within control of our company.

Damage or claims for products not being available for use, or for lost data or lost software.

Damage occurring to product during shipping.

Failure to operate per Owner's Manual.